

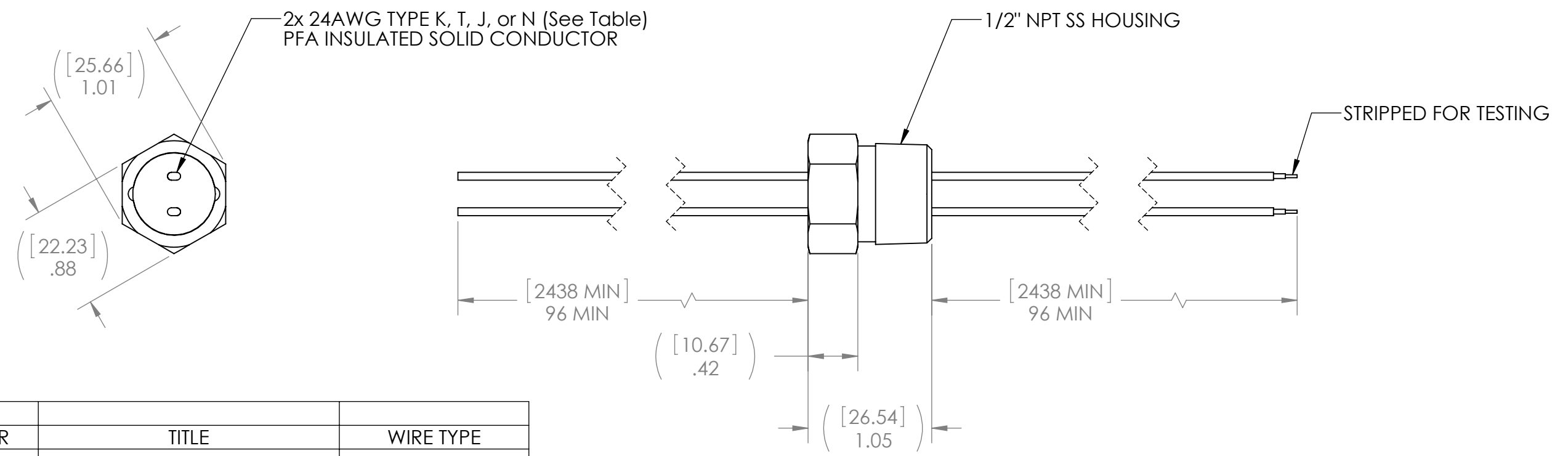

REVISIONS				
ZONE	REV.	DESCRIPTION	DATE	APPROVED
	A	INITIAL RELEASE	07-Oct-2019	MN



PART NUMBER	TITLE	WIRE TYPE
60678-K	CABLE SEAL 1/2NPT SS316 (2P)#24 TYPE K PFA 96-96	TYPE K
60678-T	CABLE SEAL 1/2NPT SS316 (2P)#24 TYPE T PFA 96-96	TYPE T
60678-J	CABLE SEAL 1/2NPT SS316 (2P)#24 TYPE J PFA 96-96	TYPE J
60678-N	CABLE SEAL 1/2NPT SS316 (2P)#24 TYPE N PFA 96-96	TYPE N

- NOTES:
1. HELIUM LEAK TEST @ 1 ATM 1X10⁻⁸ STD-CC/SEC OR BETTER, VACUUM ON THREAD SIDE.
 2. PRESSURE TEST 1,000 PSI NO BUBBLES 3 MINUTES WITH PRESSURE ON THREAD SIDE.
 3. HYPOT 300VDC 300 MEGOHMS 1 SECOND MINIMUM.
 4. SEAL OPERATING TEMPERATURE -20C TO 130C (WIRE TEMPERATURE RATING IS 250C).
 5. DIMENSIONS ARE INCHES [MILLIMETERS], MILLIMETERS SHOWN FOR REFERENCE ONLY.
 6. CUSTOM SIZES, WIRE OR FIBER OPTIC CONFIGURATIONS, & TESTS AVAILABLE, PLEASE CONTACT RHS FOR MORE INFORMATION.

UNLESS OTHERWISE SPECIFIED:	NAME	DATE		
DIMENSIONS ARE IN INCHES	DRAWN	MM		07FEB2021
TOLERANCES:	CHECKED			
FRACTIONAL ±1/16	ENG APPR.	MN		07FEB2021
ANGULAR ±.5	MFG APPR.			
X. ±1 .X ±.1	Q.A.			
.XX ±.02 .XXX ±.005	PROPRIETARY AND CONFIDENTIAL THE INFORMATION CONTAINED IN THIS DRAWING IS THE SOLE PROPERTY OF RELIABLE HERMETIC SEALS. ANY REPRODUCTION IN PART OR AS A WHOLE WITHOUT THE WRITTEN PERMISSION OF RELIABLE HERMETIC SEALS IS PROHIBITED.			
INTERPRET GEOMETRIC TOLERANCING PER:	SIZE	DWG. NO.	REV	
MATERIAL	B	60678	A	
SEE ABOVE	SCALE: 1:1	WEIGHT:	SHEET 1 OF 1	
FINISH	SEE TABLE FOR FULL PART NUMBER			
N/A				
DO NOT SCALE DRAWING				