

REVISIONS				
ZONE	REV.	DESCRIPTION	DATE	APPROVED
	A	INITIAL RELEASE	07-Oct-2019	MN

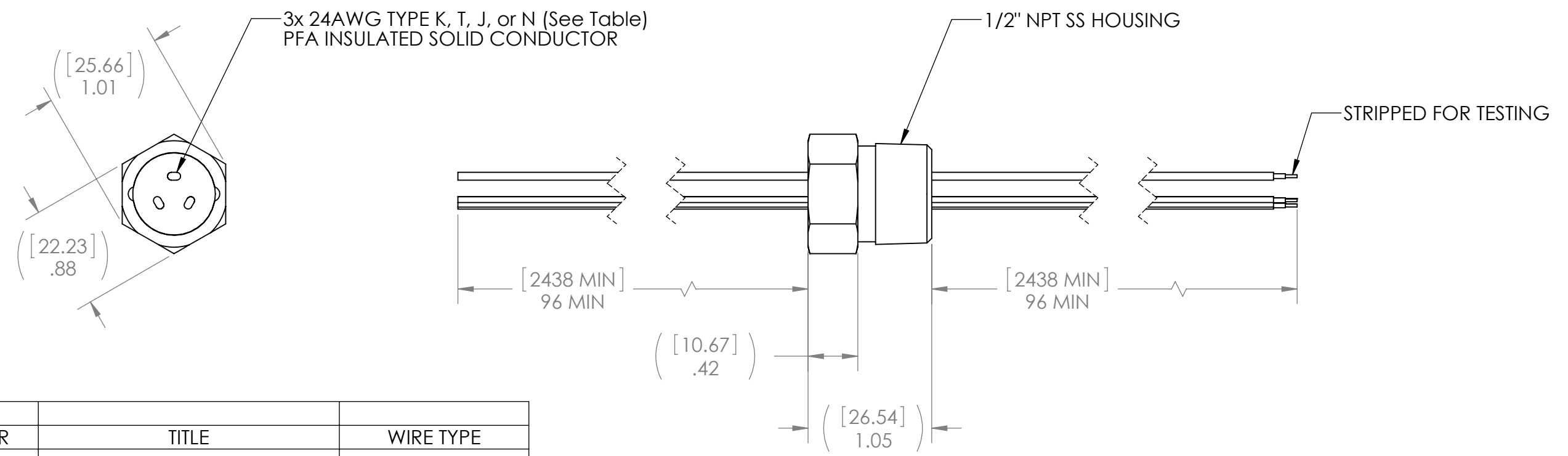

PART NUMBER	TITLE	WIRE TYPE
60679-K	CABLE SEAL 1/2NPT SS316 (3P)#24 TYPE K PFA 96-96	TYPE K
60679-T	CABLE SEAL 1/2NPT SS316 (3P)#24 TYPE T PFA 96-96	TYPE T
60679-J	CABLE SEAL 1/2NPT SS316 (3P)#24 TYPE J PFA 96-96	TYPE J
60679-N	CABLE SEAL 1/2NPT SS316 (3P)#24 TYPE N PFA 96-96	TYPE N

- NOTES:
1. HELIUM LEAK TEST @ 1 ATM 1X10⁻⁸ STD-CC/SEC OR BETTER, VACUUM ON THREAD SIDE.
 2. PRESSURE TEST 1,000 PSI NO BUBBLES 3 MINUTES WITH PRESSURE ON THREAD SIDE.
 3. HYPOT 300VDC 300 MEGOHMS 1 SECOND MINIMUM.
 4. SEAL OPERATING TEMPERATURE -20C TO 130C (WIRE TEMPERATURE RATING IS 250C).
 5. DIMENSIONS ARE INCHES [MILLIMETERS], MILLIMETERS SHOWN FOR REFERENCE ONLY.
 6. CUSTOM SIZES, WIRE OR FIBER OPTIC CONFIGURATIONS, & TESTS AVAILABLE, PLEASE CONTACT RHS FOR MORE INFORMATION.

UNLESS OTHERWISE SPECIFIED:		NAME	DATE
DIMENSIONS ARE IN INCHES		DRAWN	MM 07FEB2021
TOLERANCES:		CHECKED	
FRACTIONAL ±1/16		ENG APPR.	MN 07FEB2021
ANGULAR ±.5		MFG APPR.	
X. ±1 .X ±.1		Q.A.	
.XX ±.02 .XXX ±.005		PROPRIETARY AND CONFIDENTIAL	
INTERPRET GEOMETRIC TOLERANCING PER:		THE INFORMATION CONTAINED IN THIS DRAWING IS THE SOLE PROPERTY OF RELIABLE HERMETIC SEALS. ANY REPRODUCTION IN PART OR AS A WHOLE WITHOUT THE WRITTEN PERMISSION OF RELIABLE HERMETIC SEALS IS PROHIBITED.	
MATERIAL SEE ABOVE		SIZE	DWG. NO.
FINISH N/A		B	60679
DO NOT SCALE DRAWING		SEE TABLE FOR FULL PART NUMBER	REV A
		SCALE: 1:1	WEIGHT:
		SHEET 1 OF 1	



TITLE: CABLE SEAL 1/2NPT SS316 (3P)#24 TYPE (SEE TABLE) PFA 96-96