

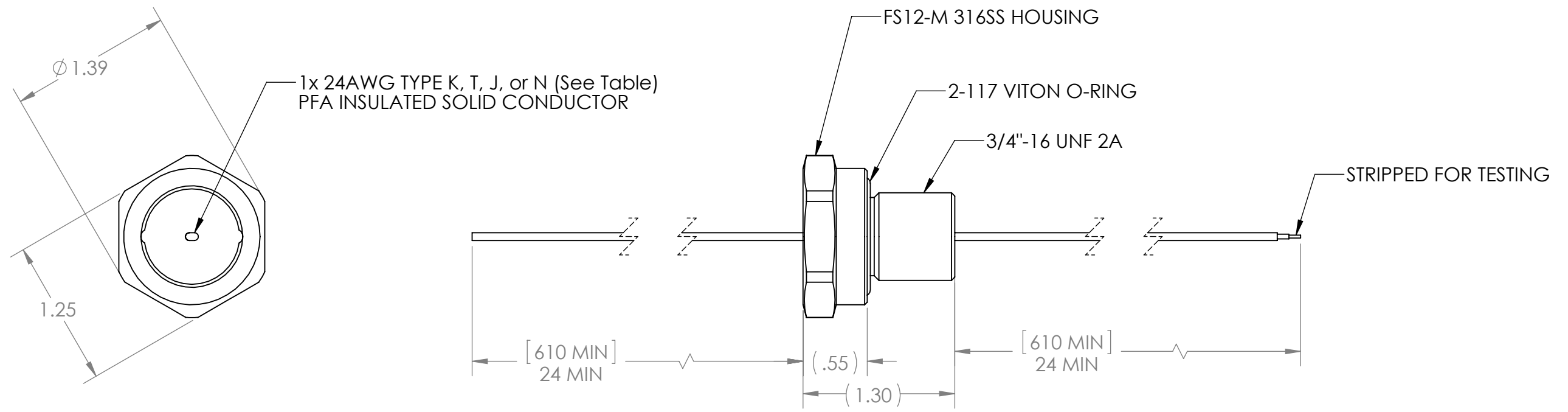

REVISIONS				
ZONE	REV.	DESCRIPTION	DATE	APPROVED
	A	INITIAL RELEASE	07-Feb-2021	MN



PART NUMBER	TITLE	WIRE TYPE
60691-K	CABLE SEAL FS12-M SS316 (1P)#24 TYPE K PFA 24-24	TYPE K
60691-T	CABLE SEAL FS12-M SS316 (1P)#24 TYPE T PFA 24-24	TYPE T
60691-J	CABLE SEAL FS12-M SS316 (1P)#24 TYPE J PFA 24-24	TYPE J
60691-N	CABLE SEAL FS12-M SS316 (1P)#24 TYPE N PFA 24-24	TYPE N

- NOTES:
1. HELIUM LEAK TEST @ 1 ATM 1X10<sup>-8</sup> STD-CC/SEC OR BETTER, VACUUM ON THREAD SIDE.
  2. HYPOT 300VDC 300 MEGOHMS 1 SECOND MINIMUM.
  3. SEAL OPERATING TEMPERATURE -20C TO 130C (WIRE TEMPERATURE RATING IS 250C).
  4. ASSEMBLY SUPPLIED WITH 304SS JAM NUT (1.0[25.4] HEX FLATS X 0.27[6.9] THICK).
  5. DIMENSIONS ARE INCHES [MILLIMETERS], MILLIMETERS SHOWN FOR REFERENCE ONLY.
  6. CUSTOM SIZES, WIRE OR FIBER OPTIC CONFIGURATIONS, & TESTS AVAILABLE, PLEASE CONTACT RHS FOR MORE INFORMATION.

UNLESS OTHERWISE SPECIFIED:	NAME	DATE		
DIMENSIONS ARE IN INCHES	DRAWN	MM		07FEB2021
TOLERANCES:	CHECKED			
FRACTIONAL ±1/16	ENG APPR.	MN		07FEB2021
ANGULAR ±.5	MFG APPR.			
X. ±1 .X ±.1	Q.A.			
.XX ±.02 .XXX ±.005	<b>PROPRIETARY AND CONFIDENTIAL</b> THE INFORMATION CONTAINED IN THIS DRAWING IS THE SOLE PROPERTY OF RELIABLE HERMETIC SEALS. ANY REPRODUCTION IN PART OR AS A WHOLE WITHOUT THE WRITTEN PERMISSION OF RELIABLE HERMETIC SEALS IS PROHIBITED.			
INTERPRET GEOMETRIC TOLERANCING PER:	SIZE	DWG. NO.	REV	
MATERIAL	<b>B</b>	<b>60691</b>	<b>A</b>	
SEE ABOVE	SCALE: 1:1	WEIGHT:	SHEET 1 OF 1	
FINISH				
N/A				
DO NOT SCALE DRAWING				